

Article number: 604144028020

Description: Timing belt pulley with hub
HTD 28 8M 20

Measures

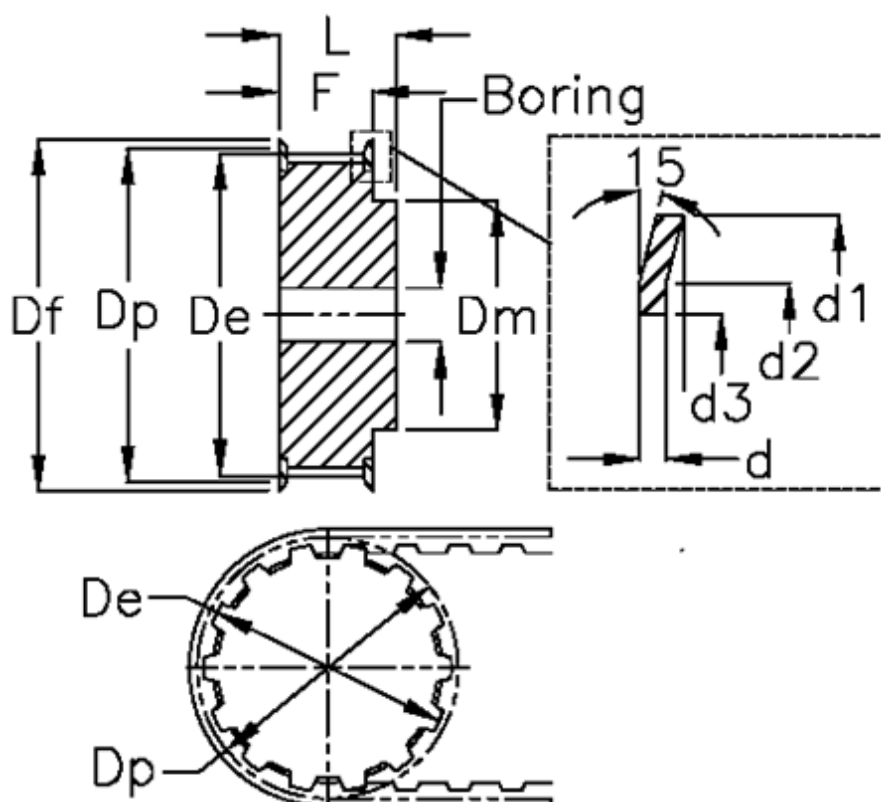

Bore = 15	Dp = 71.3
d = 1.5	F = 28
d1 = 75	Flange type = F27
d2 = 68.5	L = 38
d3 = 60	Tooth number = 28
De = 70.08	Type = 8M
Df = 75	Weight = 0.87
Dm = 50	Width = 20